

COMPARATIVE STUDY OF SINTERED SPUR GEAR FOR BOTH STANDARD AND PROFILE CORRECTED TOOTH

SHIVAPPA D¹, K. V NAGESHA² & N. SHIVAKUMARA³

¹Department of Mechanical Engineering, JGIT, Bangalore, Karnataka, India

²Department of Mechanical Engineering, AIET, Moodbidire, Karnataka, India

³Department of Mechanical Engineering, VKIT, Bangalore, Karnataka, India

ABSTRACT

Gears have been used throughout history for various purposes gearing is one of the most effective methods transmitting power and rotary motion from the source to its application with or without change of speed or direction. The rapid development of heavy industries such as vehicle, shipbuilding and aircraft industries in recent decades require advanced application of gear technology. The modeling of a sintered spur gear for both standard and profile corrected tooth. After making model from C programming is then imported to an analysis software ANSYS for carrying out the static analysis. Finally the comparisons for stress is carried out for both the standard sintered spur gear and profile corrected sintered spur gear. The interference for the profile corrected sintered spur gear was considerably less as compared to the standard sintered spur gear.

KEYWORDS: ANSYS, Von Mises Stresses

INTRODUCTION

Designing of gears are very important to an various application because of while transmission it introduces the various stress and strains because of these varies failures are usually occurs. In addition, Kamenatskaya (2011) Report that the rapid shift in the industry from heavy industries such as shipbuilding to industries such as automobile manufacture and office automation tools will necessitate a refined application of gear technology. Gears are usually used for transmitting to an rotary motion between two shafts, usually with a constant speed ratio (Sweeney, 2010). Gears have been used throughout history for various purposes, from calculations to power transmission. According to Kubo (2010), gearing is one of the most effective methods transmitting power and rotary motion from the source to its application with or without change of speed or direction. Gears will always prevail as a critical machine element for transmitting power in future machines due to their high degree of reliability and compactness. For instance in the automobile industry highly reliable and lightweight gears are essential. Furthermore the best way to reduce noise in engines requires the fabrication of silence gear system (Heywood, 2010).

The development of finite element methods for the solution of practical engineering problems begins with the advent of the digital computer (Tsay, 2009).

EXPERIMENTAL ANALYSIS

Finite element nonlinear contact analysis was chosen for modelling and simulation of gear pair in mesh. The analysis has been carried out by using software package ANSYS 10.0. Newton-Rapson's method has been used for the convergence of the results for this non-linear analysis. The load has been applied by putting in contact pinions' and wheels' teeth and applying the torsion moment on the pinion. The gear models have been discretized by 2D finite elements that are

adequate for the contact analysis. The stress state has been considered to be a plane stress and the friction has been neglected.

The single standard gear tooth and a single profile corrected tooth is considered for analysis. Our aim is to determine the stress at the root, so for this, the gear tooth at the fillet region is discretized into very small elements comparatively with other region of gear tooth. The model of the single standard tooth has 161 elements, 564 nodes and the model of a single profile corrected tooth has 131 elements, 144 nodes for a smart sizing parameter of 5, size level factor of 0.65, producing all the quadrilateral in 2D. Free mesher is used. The following Figure-1 and Figure-2 shows the meshing and the node-numbering scheme of the gear tooth for a module of 9 and a back-up ratio of 0.5.

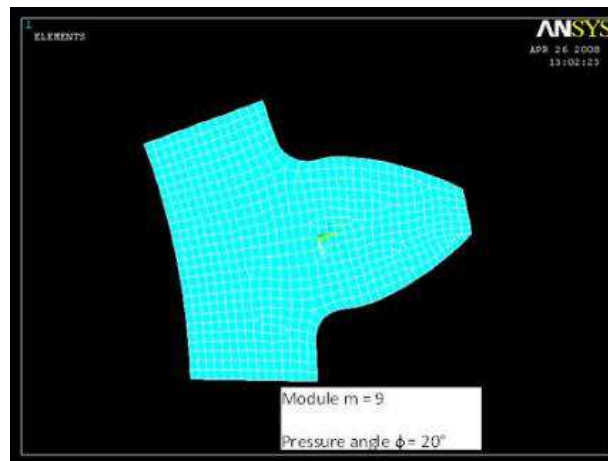

Figure 1: Meshed Gear Model

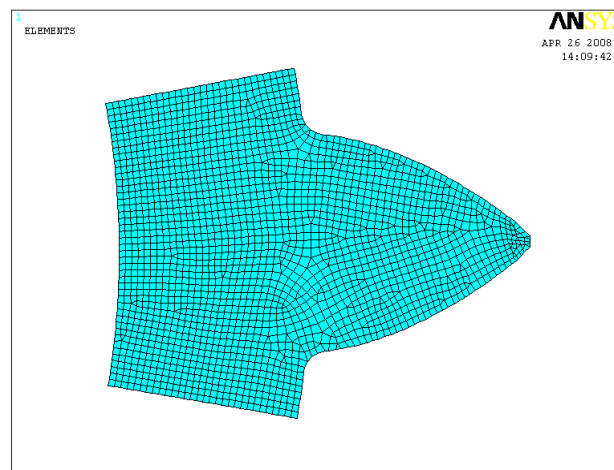

Figure 2: Meshed Model of the Profile Corrected Spur Gear

While meshing of gears, the total force transferred from the pinion to the gear is by line contact only along the face width of the gear tooth. The force acting on the body is taken as a point load in 2-D static analysis. The point load terms is considered by having a node at the point of application of the load.

Input Parameters

Addendum= 1 module, Dedendum=1.157module, Material= Sintered Iron Copper Carbon

Young's Modulus= 1.37×10^5 N/mm², Load = 26KN, Back-Up ratio = 0.5

Table 1: Material Properties for Steel

Sl. No	Description	Values
1	Poisson's Ratio	0.33
2	Young's Modulus N/mm ²	2.1 x 10 ⁵
3	Tensile yield strength (N/mm ²)	200
4	Flexural Strength (N/mm ²)	21000
5	Density g/cm ³	7.9

Table 2: Material Properties for Sintered Iron Copper Carbon

Sl. No	Description	Values
1	Poisson's Ratio	0.3
2	Young's Modulus N/mm ²	1.37 X 10 ⁵
3	Tensile yield strength (N/mm ²)	460
4	Flexural Strength (N/mm ²)	700
5	Density g/cm ³	7.6-8.1

MODELLING AND ANALYSIS

True bending stresses at the tooth root of spur gears are quite different from the nominal value that are utilized for the calculation of load capacity, either by standards or usual design rules and accurate FEM analysis has been done of the 'true' stress at tooth root of spur gears in the function of the gear geometry. The obtained results confirm the importance of these difference.

In the case of tooth bending strength, a cantilever – beam model is generally used to compute the bending stress. With this approach, Lewis in 1892 first calculated the tooth root stress of spur gear teeth (W. Lewis, "Investigation of the strength of Gear teeth", proceedings of engineers club, Philadelphia). This model is still the basis for standard calculation method successfully used in gear design. However, the local stress state – the 'true' stress – in the tooth root fillet may be different from the nominal values obtained by this method.

In a non-linear finite element analysis the load is applied in increments until the maximum load is achieved. In each succeeding increment the Von Mises stresses are higher and spread out to more teeth as these teeth come in contact. The Von Mises stresses in the test gears at maximum load, 26KN.

The yield stress is exceeded in a few locations. When repeated stresses are in excess of the yield stress low cycle fatigue occurs, i.e., failure takes place after a relatively few cycles. Three sets of teeth are in contact simultaneously at the maximum torque, thus a certain amount of load sharing occurs. Traditional gear formulas, created primarily to design metal gears, cannot give this information directly.

The 26KN torque is applied in several increments. Each torque increment causes additional tooth deformation and an increase in the stresses until the full load is applied. At maximum torque, the Von Mises stresses exceed the yield strength of the material at least one location. Since the point of yielding moves as pairs of teeth come in contact, a low cycle fatigue process is set in motion. The various Stress Contour – Von – Mises Stress For different correction Factors as shown in Figures 4, 5, 6.

STRESS CALCULATION FOR SINTERED GEAR

Considering the gear tooth as a cantilever beam fixed at one end and the load being applied at tip as shown in the Figure below, the stress values are calculated.

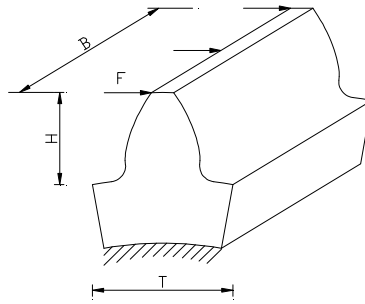

Figure 3: F_s = Stress, F_t = Tangential Tooth Load, h = Tooth Height, b = Face Width, t = Whole Depth

$$F_s = \frac{F_t \times h}{1/6 bt^2}$$

Where,

$h = 21.6\text{mm}$, $b = 90\text{mm}$, $t = 14.28\text{mm}$

$$\therefore F_s = \frac{26426 \times 21.6}{1/6 \times 90 \times (14.28)^2} \quad F_s = 187\text{N/mm}^2$$

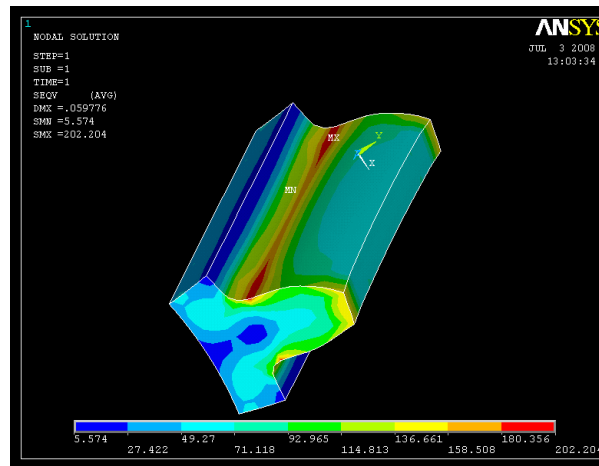

Figure 4: Stress Contour – Von – Mises Stress for $m = 9$, Correction Factor = 0

COMPARISON OF GEAR PARAMETERS

PCD=200mm, Module=9, Z=22, $\Phi=20^\circ$

Table 3: Comparison of Gear Parameters for Different Correction Factors

Parameters (mm)	Correction Factor (X) mm				
	+0.43	+0.62	0	-0.43	-0.62
Addendum Dia	225.74	227.2	218	210.26	207
Dedendum Dia	185.24	186.7	179	169.76	166.34
Base Circle	188	188	188	188	188
Tooth Thickness	16.95	18.2	14.28	11.32	10.1
Tooth Height	21.6	21.6	21.6	21.6	21.6
Addendum	12.87	14.58	9	5.13	3.42
Dedendum	6.54	4.83	10.41	14.28	15.99
Clearance	2.19	2.19	2.19	2.19	2.19

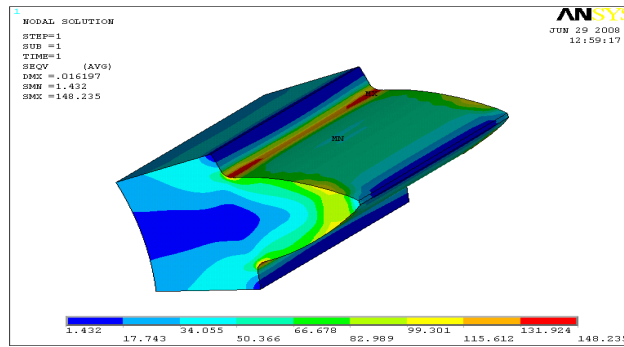

Figure 5: Stress Contour – Von – Mises Stress of Profile Corrected Spur Gear for m = 9, Correction Factor = +0.62

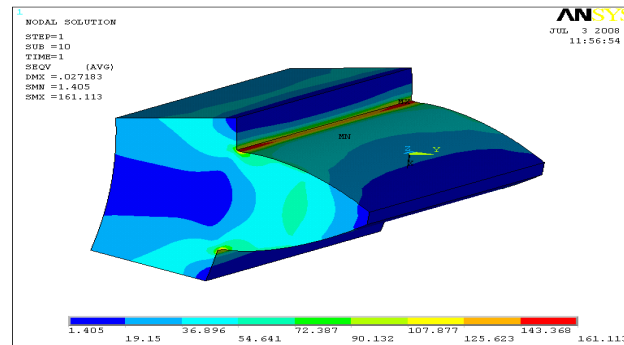

Figure 6: Stress Contour – Von – Mises Stress of Profile Corrected Spur Gear for m = 9, Correction Factor = +0.43

RESULTS OF STRESS ANALYSIS

Table 4: Von-Mises Stress for Standard and Profile Corrected Sintered Spur Gear

Module (mm)	Von-Mises Stress (MPa) for Standard Sintered Spur Gear	Von-Mises Stress (MPa) for Profile Corrected Sintered Spur Gear
7	194	164
8	191	155
9	187	148
10	184	140

Table 5: Von-Mises Stress for Different Correction Factors

Correction Factors (x)	Von-Mises Stress (MPa)
+0.62	148
+0.43	161
0	190
-0.43	202
-0.62	212

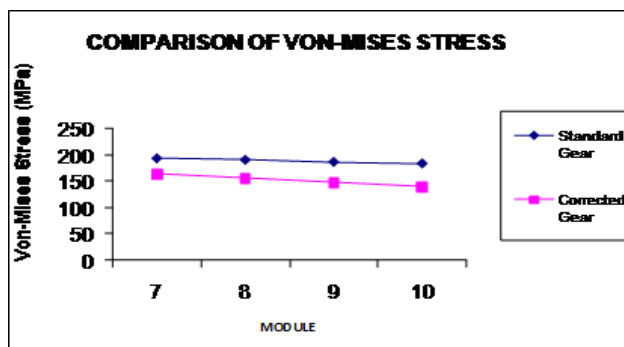

Figure 7: Comparison of Standard Tooth Results

CONCLUSIONS

Modeling of gear by using the C-program the involute profile is created and the output of C-program is converted to the DXF file conversion after that the models of the standard and corrected spur gear tooth is imported to the ANSYS through IGES file conversion. From the ANSYS the von mises stress is calculated for the standard and corrected spur gear tooth. From the above discussion about the stress analysis, it is finalized that the maximum stress concentration occurs at the root of the gear tooth. With the increase in correction factors the stress value decreases.

REFERENCES

1. Kamenatskaya, M. P. (2011) Computer-Aided Design of Optimal Speed Gearbox Transmission Layouts. *Journal of Machines and Tooling*, Vol. 46, No.9, pp.11-15.
2. Sweeney, P. J. (2010) Gear transmission error measurement and analysis. PhD dissertation, University of New South Wales, Australia.
3. Buckingham, E. (2009) *Analytical Mechanics of Gears*. McGraw-Hill, New York.
4. Kubo, A. (2010) Estimation of transmission error of cylindrical involute gears by tooth contact pattern. *JSME int. J., Ser. III*, Vol. 34(2), pp. 252-259.
5. Heywood, R. B. (2010) *Designing by Photoelasticity*. Chapman and Hall, Ltd.
6. Chong, T. H., Bar, I. (2011) Multiobjective optimal Design of Cylindrical Gear Pairs
7. Coy, J. J., Chao, C. H. S. (2009) A method of selecting grid size to account for Hertz deformation in finite element analysis of spur gears. *Trans. ASME, J. Mech. Design* Vol. 104, pp. 759-766.
8. Colbourne, J.R. (1987) *The Geometry of Involute Gears*, Springer-Verlag, New York.
9. Cockerham, G. (2009) Computer-Aided Design of Spur or Helical Gear Train. *Computer-Aided Design*, Vol.8, No. 2, pp. 84-88.
10. Cornell, R. W., Westervelt, W. W. (2009) Dynamic Tooth Loads and Stressing for High Contact Ratio Spur Gears. *ASME, Journal of Mechanical Design*, Vol. 100.
11. David, L. G., Handschuh F. R. (2010) Consideration of Moving Tooth Load in Gear Crack Propagation Predictions. *Transactions of the ASME*, Vol.123, pp. 118-124.
12. Demenego, D., Vecchiato, F.L. Litvin, N. Nervegna, S. Manco (2012) Design and simulation of meshing of a cycloidal pump, *Journal of Mechanism and Machine Theory*, Vol. 37, pp. 311–332.
13. Udley, D.W. (1962) *Gear Handbook*. Mc Graw-Hill, Newyork, 1962
14. Earle Buckingham (2010) *Manual of Gear Design*. Industrial Press, New York, 1935.
15. Errichello, D.P., Townsend, P. (1992) Gear tooth calculations, in: D.P. Townsend (Ed.), *Dudley's Gear Handbook*, Mc-Graw Hill, New York.